



FLOWERPOT TERRA

Who would say that through a blade from a windmill could be obtained much of the urban and domestic furniture?

SOSTYL AIR[®]

GIVE A SECOND LIFE TO THE SO CALLED EVIL WASTE OF ENERGY WIND POWER FOR ITS RECONVERSION INTO A WIDE RANGE OF PRODUCTS LIKE,

BENCHES, FLOWERPOTS, TABLES, CHAIRS, LAMPS...

ECOLOGICAL AND SUSTAINABLE



DESCRIPTION: Design Flowerpot for indoor and outdoor use. The depth allows the correct growth of any natural vegetation. Its weight prevents undesired displacements in adverse weather conditions.

Measures*:	Height	Width	Length
	40 cm	50 cm	40 cm
	40 cm	50 cm	60 cm
	60 cm	50 cm	100 cm
	60 cm	50 cm	120 cm

Approximate measurements

Colour: Basic presentation in white and black. The customer can customise the exterior colour of the pot according to their needs, at a cost of 25€, being this option free of charge from 5 units upwards. Sustainable Production.

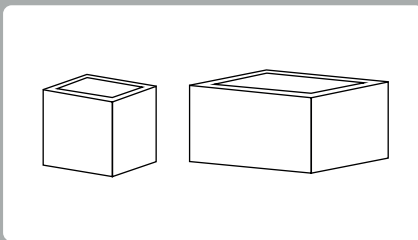

*There is the option of of customised measurements

Ventos Metódicos Reciclagem LDA.
Polígono Industrial da Lagoa. Rua das Cruzes, 484
4950-850 Monção. Portugal

info@sostylair.eu

Teléfono: +34 62686 86 30



Flowerpot TERRA

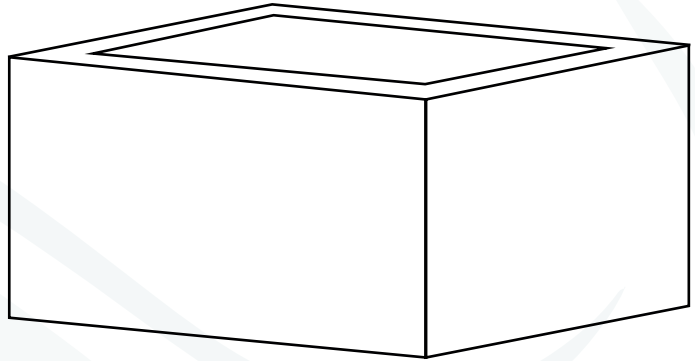
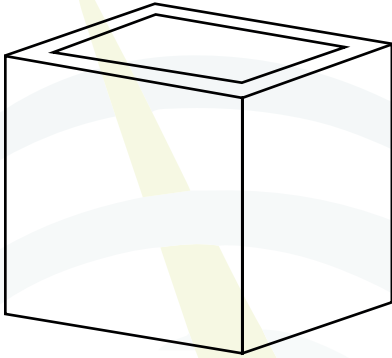

REF: 0014

Measures*

Length: 40, 60, 100 or 120 cm
Width: 50 cm
Height: 40 cm

Weight

5 - 15 Kg

Paint Temperature

Max. 85°C

Color

White
Black
Customised

Content

1 Flowerpot Terra

Packaging Measures

Length: 40, 60, 100 or 120 cm
Width: 50 cm
Height: 40 cm

Warranty

2 Years

*Approximate measurements

Made with recycled materials. 95% sustainable.



Polígono Industrial da Lagoa
Rua das Cruzes, nº 484
4950-850 Monção
Portugal

 www.ventosmetodicos.com
 +351 258 099 691





FLOWERPOT GRAN TERRA

Who would say that through a blade from a windmill could be obtained much of the urban and domestic furniture?

SOSTYL AIR®

GIVE A SECOND LIFE TO THE SO CALLED EVIL WASTE OF ENERGY WIND POWER FOR ITS RECONVERSION INTO A WIDE RANGE OF PRODUCTS LIKE,

BENCHES, FLOWERPOTS, TABLES, CHAIRS, LAMPS...

ECOLOGICAL AND SUSTAINABLE



DESCRIPTION: Design Flowerpot for indoor and outdoor use. The depth allows the correct growth of any natural vegetation. Its weight prevents undesired displacements in adverse weather conditions.

Medidas*:	Height	Width	Length
	75 cm	60 cm	150 cm
	75 cm	60 cm	180 cm
	75 cm	60 cm	200 cm

Approximate measurements

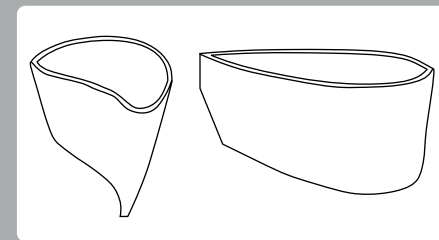

Colour: Basic presentation in white and black. The customer can customise the exterior colour of the pot according to their needs, at a cost of 25€, being this option free of charge from 5 units upwards.
Sustainable Production.

*There is the option of customised measurements

Ventos Metódicos Reciclagem LDA.
Polígono Industrial da Lagoa. Rua das Cruzes, 484
4950-850 Monção. Portugal

info@sostylair.eu

Telefone: +34 62686 86 30



Flowerpot GRAN TERRA

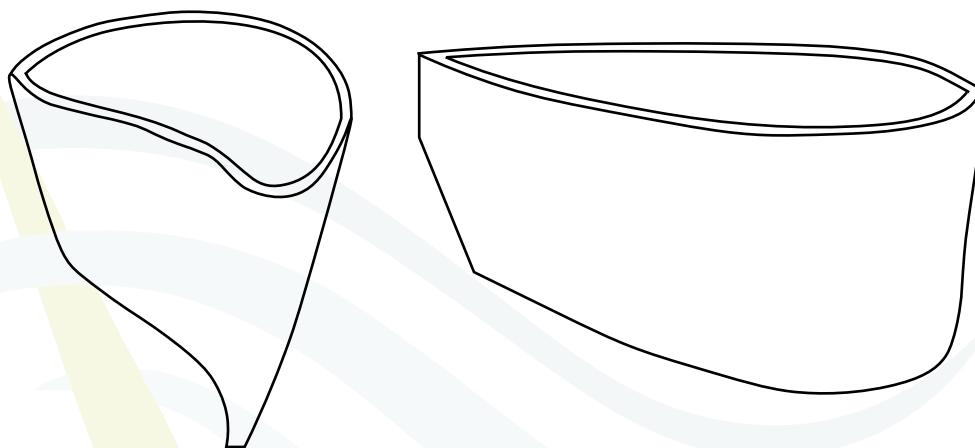

REF: 0015

 **Measures***

Length: 150, 180 or 200 cm
Width: 60cm
Height: 75cm

 **Weight**

80 Kg

 **Paint Temperature**

Max. 85°C

 **Color**

White
Black
Stone effect
Customised

 **Content**

1 Flowerpot Gran Terra

 **Packaging Measures**

Length: 150, 180 or 200 cm
Width: 60cm
Height: 75cm

 **Warranty**

2 Years

*Approximate measurements

Made with recycled materials. 95% sustainable.



Poligono Industrial da Lagoa
Rua das Cruzes, n° 484
4950-850 Monção
Portugal

 www.ventosmetodicos.com
 +351 258 099 691





ROUND FLOWERPOT

OUTDOOR

Who would say that through a blade from a windmill could be obtained much of the urban and domestic furniture?



GIVE A SECOND LIFE TO THE SO CALLED EVIL WASTE OF ENERGY WIND POWER FOR ITS RECONVERSION INTO A WIDE RANGE OF PRODUCTS LIKE,

BENCHES, FLOWERPOTS, TABLES, CHAIRS, LAMPS...

ECOLOGICAL AND SUSTAINABLE



DESCRIPTION: Round shaped pot. Its weight prevents unwanted displacement.

Measures*:	Diameter	100, 150, 170, 185, 190 or 210 cm
	Height	60 to 80 cm
	Approximate measurements	

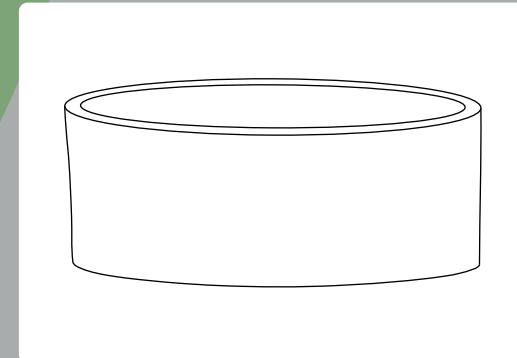

Colour: Basic presentation in white and black. The customer can customise the external colour of the flowerpot according to their needs, at a cost of 50€, with this option being free of charge for orders of 5 units or more. Sustainable production.

*There is the option of customised measurements

Ventos Metódicos Reciclagem LDA.
Polígono Industrial da Lagoa. Rua das Cruzes, 484
4950-850 Monção. Portugal

info@sostylair.eu
Teléfono: +34 62686 86 30



ROUND Flowerpot



REF: 0025

 Measures*

Diameter: 100, 150, 170, 185, 190 or 210 cm
Height: 60 to 80 cm

 Weight

150 - 200 Kg

 Paint Temperature

Max. 85°C

 Color

White
Black
Customised

 Content

1 Round Flowerpot

 Packaging Measures

Diameter: 100, 150, 170, 185, 190 or 210 cm
Height: 60 to 80 cm

 Warranty

2 Years

*Approximate measurements

Made with recycled materials. 95% sustainable.



Polígono Industrial da Lagoa
Rua das Cruzes, n° 484
4950-850 Monção
Portugal

 www.ventosmetodicos.com
 +351 258 099 691





FLOWERPOT U

Who would say that through a blade from a windmill could be obtained much of the urban and domestic furniture?

SOSTYL AIR[®]

GIVE A SECOND LIFE TO THE SO CALLED EVIL WASTE OF ENERGY WIND POWER FOR ITS RECONVERSION INTO A WIDE RANGE OF PRODUCTS LIKE,

BENCHES, FLOWERPOTS, TABLES, CHAIRS, LAMPS...

ECOLOGICAL AND SUSTAINABLE



DESCRIPTION: Design Flower pot for indoor and outdoor use. The depth allows the correct growth of any natural vegetation. Its weight avoids undesired displacements in adverse weather conditions.

Measures*:	Height	Width	Length
	40 to 60 cm	40 to 60 cm	50 cm
	40 to 60 cm	40 to 60 cm	100 cm
	40 to 60 cm	40 to 60 cm	150 cm

Approximate measurements

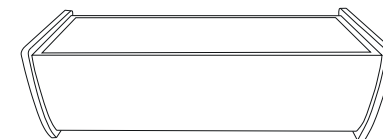

Colour: Basic presentation in white and black. The customer can customise the exterior colour of the flowerpot according to their needs, at a cost of 25€, being this option free of charge from 5 units upwards.
Sustainable production.

*There is the option of customised measurements

Ventos Metódicos Reciclagem LDA.
Polígono Industrial da Lagoa. Rua das Cruzes, 484
4950-850 Monção. Portugal

info@sostylair.eu

Teléfono: +34 62686 86 30



Flowerpot U



REF: 0016

 **Measures***

Length: 50, 100 or 150 cm
Width: 40 to 60 cm
Height: 40 to 60 cm

 **Weight**

20 - 60 Kg

 **Paint Temperature**

Max. 85°C

 **Color**

White
Black
Customised

 **Content**

1 Flowerpot U

 **Packaging Measures**

Length: 50, 100 or 150 cm
Width: 40 to 60 cm
Height: 40 to 60 cm

 **Warranty**

2 Years

*Approximate measurements

Made with recycled materials. 95% sustainable.



Polígono Industrial da Lagoa
Rua das Cruzes, nº 484
4950-850 Monção
Portugal

 www.ventosmetodicos.com
 +351 258 099 691





FLOWERPOT MINI

Who would say that through a blade from a windmill could be obtained much of the urban and domestic furniture?

SOSTYL AIR®

GIVE A SECOND LIFE TO THE SO CALLED EVIL WASTE OF ENERGY WIND POWER FOR ITS RECONVERSION INTO A WIDE RANGE OF PRODUCTS LIKE,

BENCHES, FLOWERPOTS, TABLES, CHAIRS, LAMPS...

ECOLOGICAL AND SUSTAINABLE



DESCRIPTION: Design Flowerpot for indoor and outdoor use. The depth allows the correct growth of any natural vegetation.

Measures*:
 Height 10 to 20 cm
 Width 10 to 20 cm
 Length 80 to 100 cm
 Approximate measurements

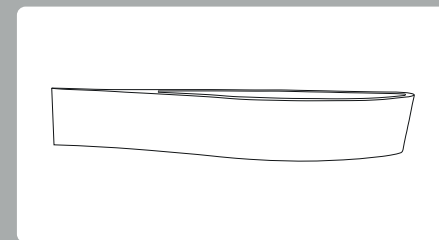

Colour: Basic presentation in white and black. The customer can customise the exterior colour of the pot according to their needs, at a cost of 25€, being this option free of charge from 5 units upwards. Sustainable production.

*There is the option of customised measurements

Ventos Metódicos Reciclagem LDA.
 Polígono Industrial da Lagoa. Rua das Cruzes, 484
 4950-850 Monção. Portugal

info@sostylair.eu
 Teléfono: +34 62686 86 30



Flowerpot Mini

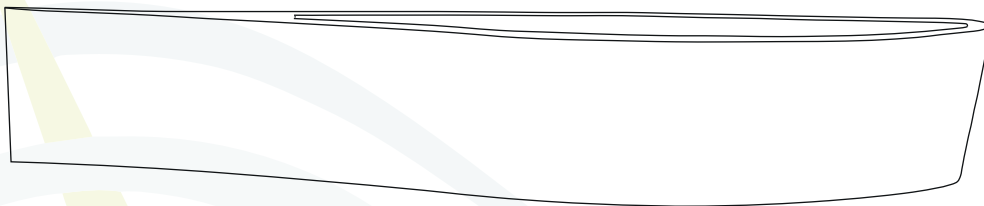

REF: 0017

 **Measures***

Length: 80 to 100 cm
Width: 10 to 20 cm
Height: 10 to 20 cm

 **Weight**

1 - 3 Kg

 **Paint Temperature**

Max. 85°C

 **Color**

White
Black
Customised

 **Content**

1 Flowerpot Mini Maceta

 **Packaging Measures**

Length: 80 to 100 cm
Width: 10 to 20 cm
Height: 10 to 20 cm

 **Warranty**

2 Years

*Approximate measurements

Made with recycled materials. 95% sustainable.



Poligono Industrial da Lagoa
Rua das Cruzes, nº 484
4950-850 Monção
Portugal

 www.ventosmetodicos.com
 +351 258 099 691

